

Comfort Grip Grab Bar

Item Code and Description

- a. GB1932-GR . . . 32" Comfort Grip Grab Bar (gray)

General Product Description

- a. straight, heavy-duty grab bar with grooved grips

Physical Characteristics

- a. complies with ADA requirements
- b. grip supported by thick aluminum pipe
- c. unplasticized polyvinyl chloride (UPVC) grip cover and brackets
- d. fluted grip covers
- e. smooth brackets
- f. grip color: gray
- g. grip diameter: 1¼"
- h. distance between wall and grip: 1½"
- i. bracket color: white
- j. end brackets and intermediate bracket
- k. escutcheons cover all mounting plates and fasteners
- l. cap provided for covering bolt that secures intermediate mounting plate to bracket
- m. grip segments are permanently bonded to brackets (cannot separate brackets from grips)
- n. five pilot holes for fasteners in each end bracket mounting plate; four pilot holes for fasteners in intermediate bracket mounting plate
- o. fasteners are not included due to the vast variety of wall and blocking materials and thicknesses

Performance Characteristics

- a. grooves and ridges provide a very secure, grippable surface, even when wet
- b. grip remains warm to the touch compared to metal grab bars
- c. rust-free construction
- d. aluminum core offers great strength
- e. supports up to 419 lbs. maximum vertical static load when secured properly to brick, concrete, concrete block, or substantial solid wood blocking
- f. easy to clean (use mild detergent; do not use abrasive pads, or strong acidic, alkaline or other harsh cleaning materials as this may cause discoloration). After cleaning, always flush with water.
- g. pull escutcheons away from mounting plates to expose pre-drilled holes for fasteners
- h. to release an escutcheon from a mounting plate, either twist and lift the escutcheon or insert the tip of a flat head screwdriver into the discreet slot and use it to lift the escutcheon off the plate
- i. grab bars must be mounted to substantial, well-secured blocking usually of 2x solid wood (toenailing is not sufficient; use cleats or notch blocking into studs), though brick, concrete, or concrete block can also be suitable mounting materials
- j. #10 round head fasteners or hex head fasteners recommended (do not use flat head type fasteners; use stainless steel fasteners in wet area installations; each fastener must be capable of withstanding 77 lbs. of pull-out force; the length of fasteners will depend on the distance to drive them deeply into an appropriately reinforced surface capable of supporting the load; drive a properly sized fastener into every mounting plate pilot hole to achieve the full load rating
- k. recommended for interior installations only
- l. made of 100% recyclable materials

Other Information

- a. 5-year limited warranty when installed in commercial settings
- b. 10-year limited warranty when installed in residential settings
- c. see AKW warranty for details

Comfort Grip Grab Bar

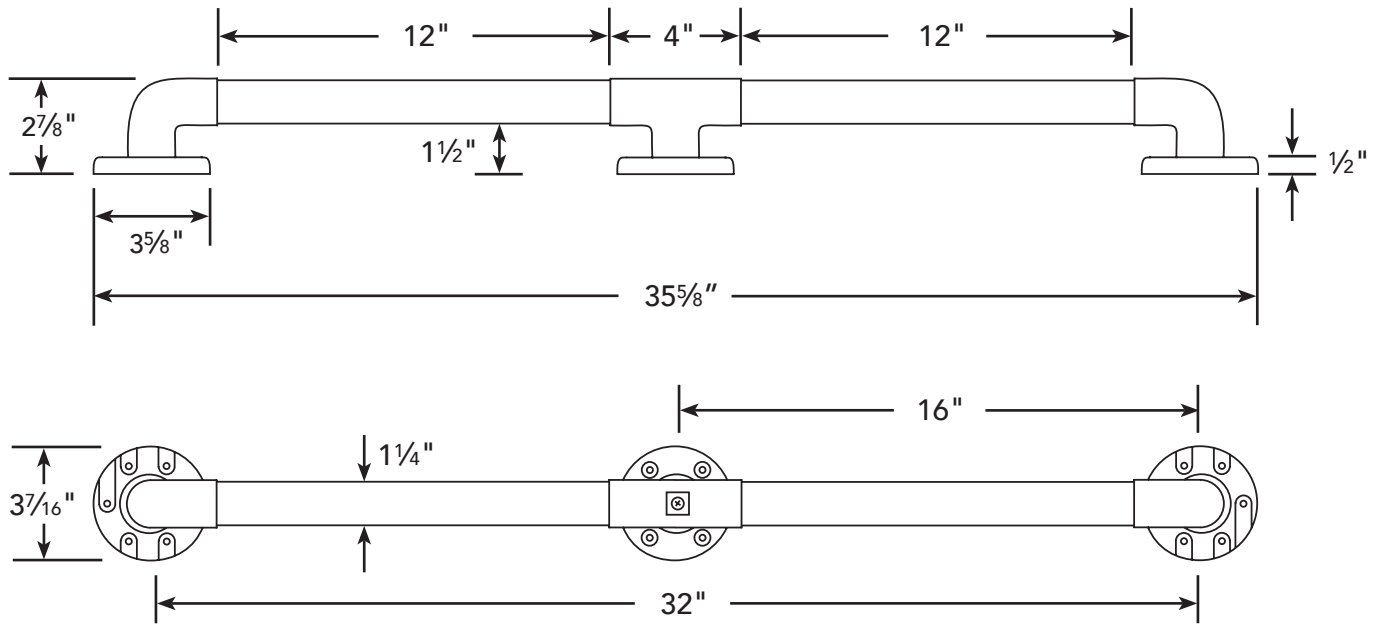

Use cap (provided) to cover bolt securing intermediate bracket.

Escutcheons removed to show mounting plates.

